

Vetina CS3

Veterinary HD Rigid Endoscopy System

Medical Quality , Veterinary-Specific



Vetina CS3

Mindray Animal Medical are committed to offering human standard equipment and provides an animal-specific endoscope system with 1080P Full HD imaging by meeting demands of vets.



Built-in USB Recording



Four Insufflation Modes Available



Endoscopes & Consumables for Different Procedures



Full Optical Bonding Medical Monitor



3-chip CMOS Sensor
2X Optical Zoom



Image Presets for Four Different Procedures





Medical Quality

Vetina camera head

suitable for veterinary practice

- Exclusive design to help keep balance
Lightweight, reduces surgeon fatigue during long procedures
- IPX7 waterproof rating
Submersible for cleaning & disinfection



Optical Zoom Ensures Less Image Artifact

- Focal length: 14-30mm, 2X optical zoom without losing quality

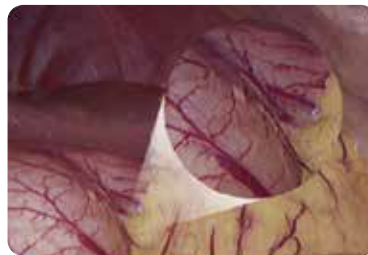

| 2X optical zoom |



| 2X electronic zoom |

3-Chip CMOS Powerful Image Processing Device

Compared with CCD, CMOS has better light sensitivity and less noise. The sensors process the three primary colors separately, presenting more realistic colors and clearer organization details, while realizing zooming and focusing simultaneously.



CMOS performance



CCD performance



Medical Quality

Powerful image post-processing technology

- Brightness level adjusts automatically for immediate identification of hemorrhage
- Effectively reduces motion blur
- Image presets for four different procedures

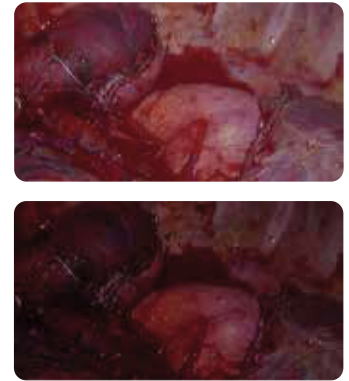

27" Full Optical Bonding Medical Monitor



- Medical standard
- Full sealed: allowing wipe disinfection, prevent moisture getting into the display
- LOCA bonding: Better transparency, anti-glare, 178 degree viewing angle

Optical Bonding Panel Technology

Suppress the reflection and retraction of light

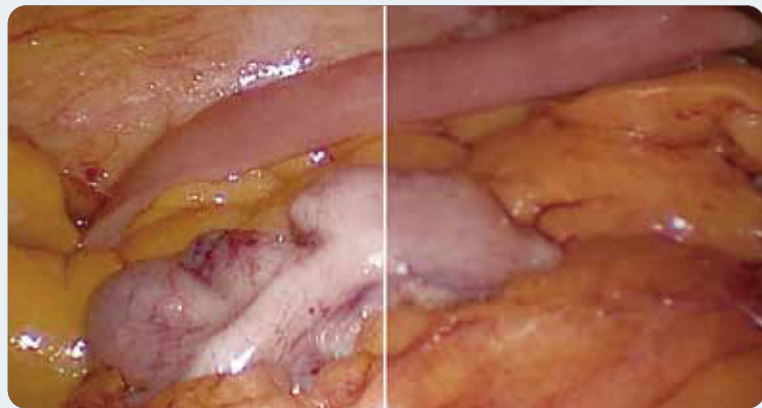

LOCA bonding panel

Normal panel



Veterinary-Specific

Veterinary Insufflator Vetina GS3

- Mindray's exclusive algorithm provides stable pressure
- Preset values specific for veterinary medicine
- Four insufflation modes available



7" Touch screen

Low-cost After Sales Service

Maintenance-free LED Light Source Vetina LS3

- Equivalent to 300W xenon light source
- Compatible with third-party light cable
- Maintenance-free
- Service life of 10,000 surgeons



20000h
10000 surgeons



6000K
LED light source



Veterinary-Specific

Built-in USB Recording

- FHD photo capture and video recording
- Convenient sharing and clear projection display on academic events
- Easy recording with just one click
- Meets advertising demands of private animal hospitals



Anti-Fogging HD Endoscope



*Autoclaved

*
25-150mm

extended
depth of field

Special anti-fog

technique

Effectively

avoids
lens distortion

5mm,3mm

Suitable for
veterinary applications

*Marked as LPS430M Endoscope parameters
LPS30 Endoscope's depth of field is 10-100mm



Veterinary-Specific

Endoscopes & Consumables For Different Procedures



Laparoscope

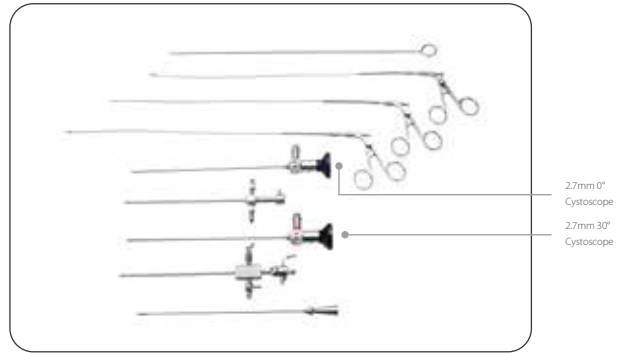

Cystoscope

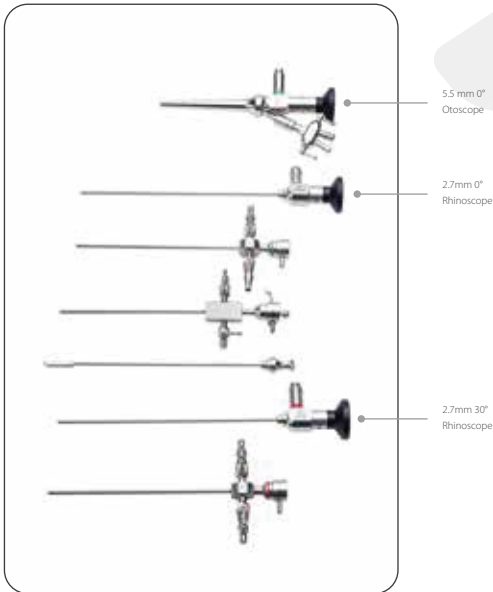

Otoscope and Rhino-Laryngoscope



Arthroscopy



Mindray Animal Medical Minimally Invasive Surgery Solution

**For more information please contact:
Endoscopy Support Services, Inc.
3 Fallsview Lane Brewster, NY 10509
845-277-1700 * www.endoscopy.com**

Vetina CS7

Veterinary 4K Rigid Endoscopy System

4K UHD Veterinary-Specific

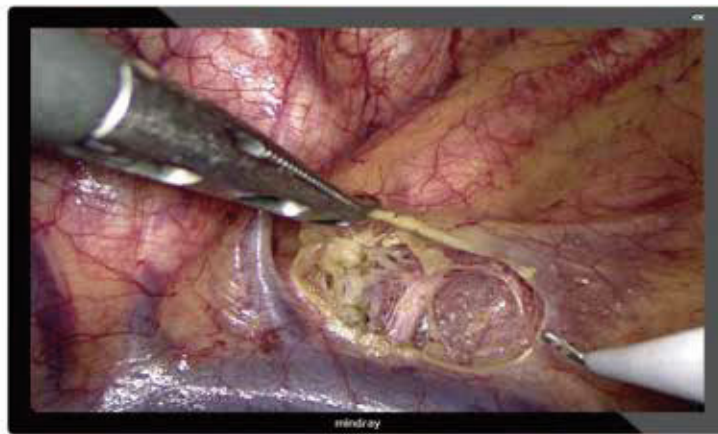

4K True Colors And Higher Resolution

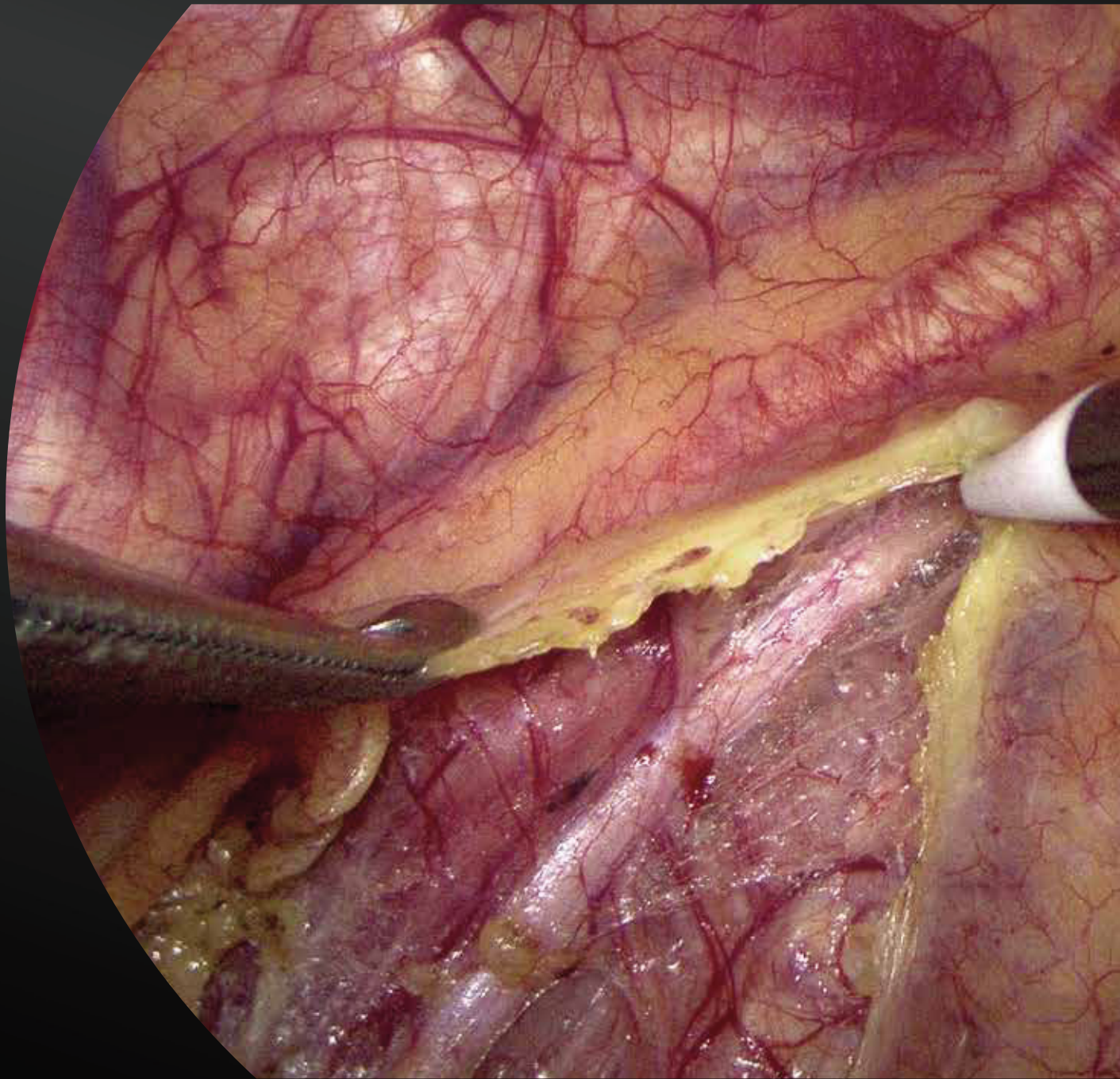



4K UHD Image

- 3840 × 2160 resolution; 4x the resolution of an HD image, with more vivid texture for accurate recognition

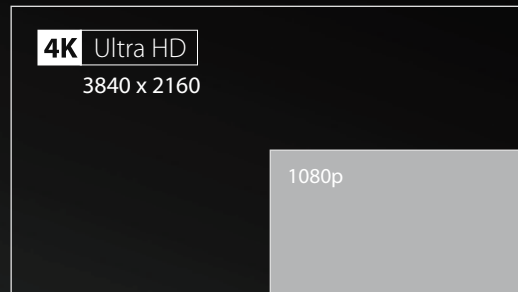

Wide Color Gamut

- Represents organs and tissues in real color, perfect identification of blood vessels, lymph nodes, and nerves.

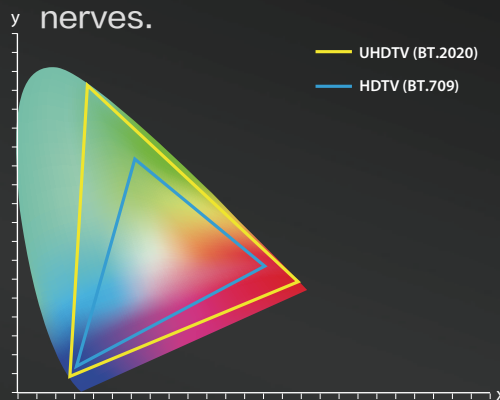

25–150mm Extended

- Focus remains clear while switching between multiple operating scenes.

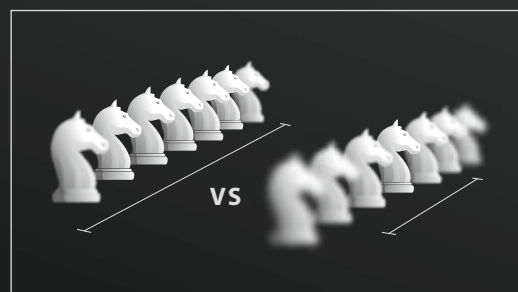

Sharpness near & far

55 " Immersive Experience



- Provide a better immersion experience
- Eliminate other interference
- Help surgeons improve concentration
- Bring an innovative operating experience
- Image can be enlarged 4 times without reducing the resolution
- Effectively reduces surgeon visual fatigue

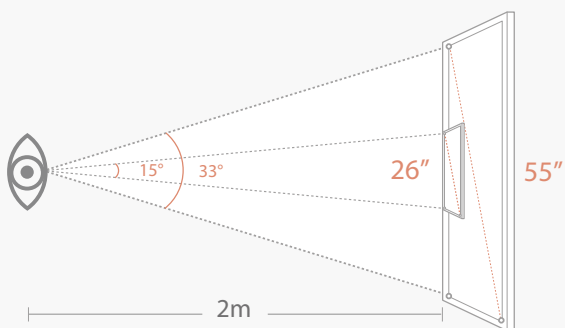

4K



HD

Built-in USB Recording



- UHD /FHD photo capture and video recording
- Easy recording with just one click
- With bookmark function, it is convenient for video record review and post-editing
- Convenient sharing and clear projection display on academic events
- Meets advertising demands of private animal hospitals

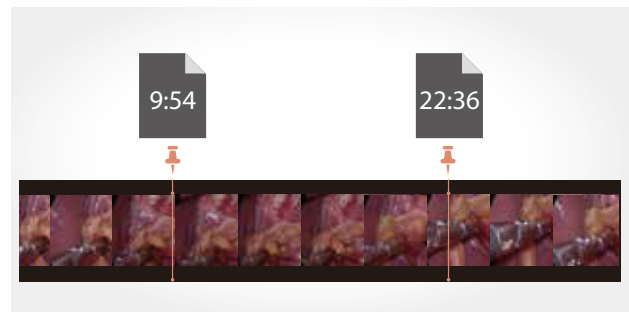

Ergonomics



Trolley TITAN

- Support a 55-inch large screen
- Four casters with brakes
- The innovative structural design ensures convenient moving



Cable Management

- The camera cup holder combined with the cable hook to prevent



7" Touch Panel

- The main functions are available with only one touch
- 10 ° tilt up screen is easier for observation



Anti-Fogging HD Endoscope

* 25-150mm
extended
depth of field

Special
anti-fog
technique

Effectively
avoids lens
distortion

5mm,3mm
Suitable for
veterinary
applications



* Autoclaved

* Marked as LP5430M Endoscope parameters
LP530 Endoscope's depth of field is 10-100mm

4K Medical Grade Monitor

- 55 " & 31 " inch selectable
- IMAX in Operating Room
- Direct bonding Technology, Reduce reflection interference

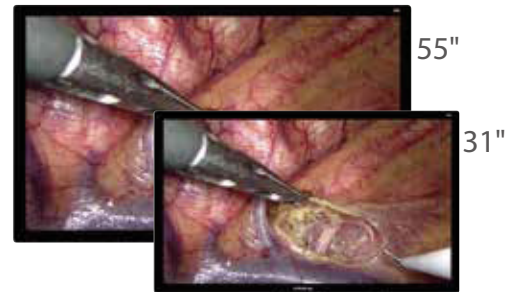

Veterinary Insufflator Vetina GS7

- Mindray's exclusive algorithm provides stable pressure
- Preset values specific for veterinary medicine
- Four insufflation modes available
- Gas heating to body temperature
- Smoke evacuation function



Veterinary Light Source Vetina LS7

- Comparable to the brightness of a xenon light source
- Long-term use to maintain low temperature
Service life of 30,000 surgeons





**For more information please contact:
Endoscopy Support Services, Inc.
3 Fallsview Lane Brewster, NY 10509
845-277-1700 * www.endoscopy.com**

TECNOIMAGEN
www.tecnoimagen.com.ar | 0810 333 8273

 **mindray**
animal care